

# FITTING GUIDE

## WALL CABINET

### FI.PK.FIT.005-WALL

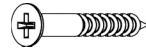

(H) 8x 1 1/4" Screws



Screws for attaching to walls are not provided as these vary depending on wall material and construction. Ensure appropriate fixings for wall construction are used.

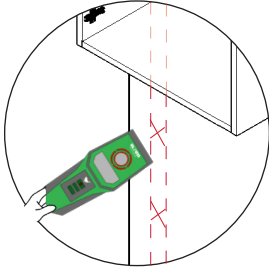

#### **Step 1.**

Use a stud finder to locate the studs. Mark the wall at the appropriate height identifying which studs to use.

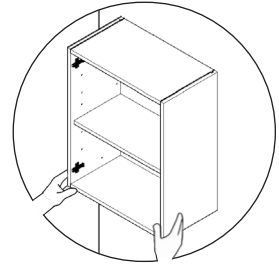

#### **Step 2.**

Offer cabinet to the wall and screw in two places in the top and bottom hanging rails where possible, securing the cabinet to the wall.

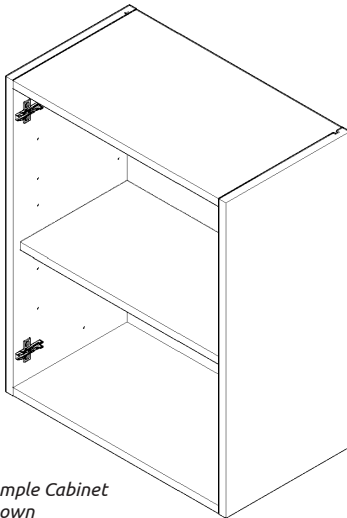

Sample Cabinet Shown

#### **Step 3.**

If a stud is not available secure to wall using suitable fixings and screw into adjacent cabinets as in step 4.

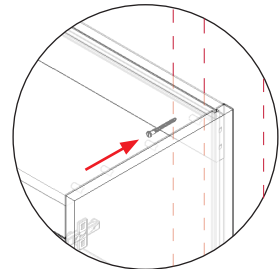
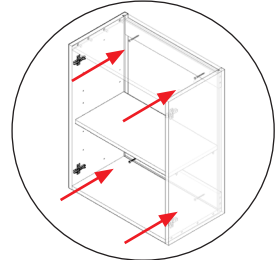

View cut away from top panel.

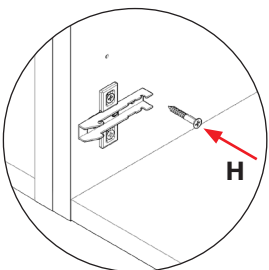

#### **Step 4.**

Screw into any adjacent cabinets using 1 1/4" screws (H) provided to secure the cabinet. Screw just to the rear of the hinge plate and to the rear of the cabinet at the top and bottom. Place a cover cap on the head to conceal it.

**wren**  
KITCHENS