

# FITTING GUIDE

## Wall Cabinet

HEIGHT: 12" - 42"

WIDTH: 6" - 42"

DEPTH: 12" - 25"

### FI.PK.FIT.005-WALL

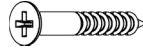

(H) 8x 1 1/4" Screws



Screws for attaching to walls are not provided as these vary depending on materials, thickness and construction. Ensure appropriate fixings for wall are used.

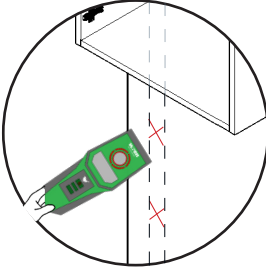

#### **Step 1.**

Use a stud finder to locate the studs. Mark the wall at the appropriate height identifying which studs to use.

#### **Step 2.**

Offer cabinet to the wall and screw in two places in the top and bottom hanging rails where possible, securing the cabinet to the wall.

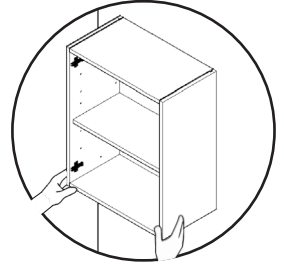

#### **Step 3.**

If a stud is not available secure to adjacent cabinet using step 4. **If an adjacent cabinet is not available, secure using a suitable fixing to the wall.**

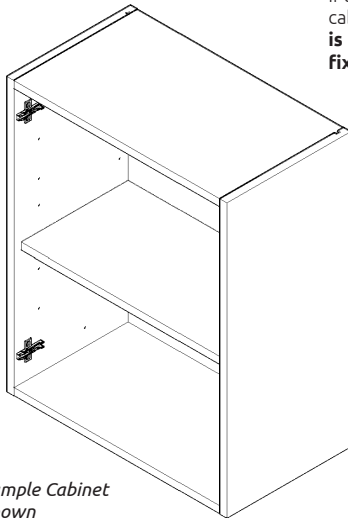

Sample Cabinet Shown

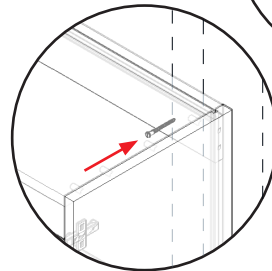

View cut away from top panel.

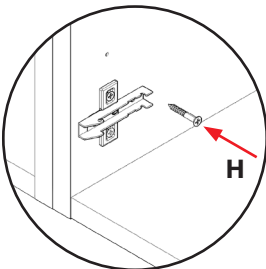
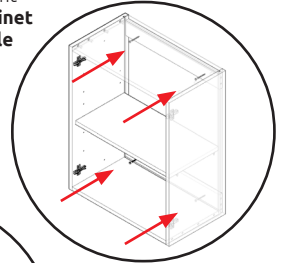

#### **Step 4.**

Screw into any adjacent cabinets using 1 1/4" screws (H) provided to secure the cabinet. Screw just to the rear of the hinge plate and to the rear of the cabinet at the top and bottom. Place a cover cap on the head to conceal it.

#### TOOLS REQUIRED

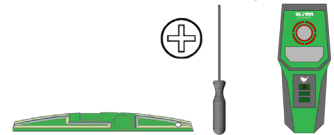

**wren**  
KITCHENS